

High Power 650nm 3-port Polarization Insensitive Optical Circulator

High Power 650nm 3-port Polarization Insensitive Optical Circulator is a fiber passive component built with TGG crystal, which can change signal light transmission path, the signal can be delivered from Port 1 to Port 2, the other signal light from Port 2 to Port 3, the high isolation can block the back reflection light. It's widely used in Fiber Amplifier System, Fiber Optic Sensor and Testing System field. If need pulse type please tell us to confirm.

Application:

Fiber Optic Sensor
Fiber Optic Amplifier
Coherent Detecting
Testing System

Features:

High Power
High Isolation
Low Insertion Loss
High Reliability



Specification:

Parameter	Symbol	Value	Unit
Center Wavelength	λ	650	nm
Bandwidth	BW	± 10	nm
Typ. Insertion Loss (Port 1 to 2, 2 to 3)	IL	1.5	dB
Max. Insertion Loss (Port 1 to 2, 2 to 3)	IL	2.0	dB
Typ. Isolation (Port 2 to 1, 3 to 2)	Iso	25	dB
Min. Isolation (Port 2 to 1, 3 to 2)	Iso	20	dB
Max. Polarization Dependent Loss	PDL	0.15	dB
Min. Cross Talk	Ct	40	dB
Min. Return Loss	RL	40	dB
Max. Optical Power (CW)	P	1, 2 or specify	W
Max. Peak Power	P	5, 10 or specify	kW
Max. Tensile Load		5	N
Fiber Type		630-HP fiber	-
Operating Temperature	T	+5~65	°C
Storage Temperature	T	-40~85	°C
Package Dimension			mm

Notice: Above specifications are tested at center wavelength without connector in room temperature @23°C.

For devices with connectors, IL will be 0.3dB higher, RL will be 5dB lower. connectors only 1W CW optical power guarantee.

Drawing:

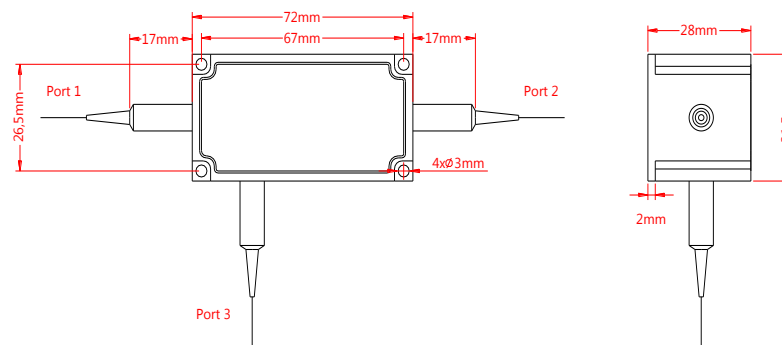

Ordering Information (Part Number):

HPICIR- WWW - P - HH - J - LL - CC					
WWW	P	HH	J	LL	CC
Wavelength	Port	Handling Power	Fiber Jacket	Fiber Length	Connector
633 - 633nm 635 - 635nm 650 - 650nm 680 - 680nm SSS - Specify	3 - 3 Ports	01 - 1W 02 - 2W SS - Specify	B - 250um Bare Fiber 9 - 900um Loose Tube	05 - 0.5m 10 - 1.0m 15 - 1.5m 20 - 2.0m SS - Specify	NE - None FA - FC/APC FU - FC/UPC SA - SC/APC SU - SU/APC LA - LC/APC LU - LC/UPC SS - Specify