

## 1550nm SM Pigtailed InGaAs PIN Photodiode

1550nm SM Pigtailed InGaAs Photodiode is a semiconductor optoelectronic product designed for detecting light signal by transferring the light signal to electric signal, SM Pigtailed InGaAs Photodiode is built with InGaAs chip material and terminated with SM pigtail to detect the light with high responsibility and low dark current, it's widely used in fiber optic sensor and optic electric communication field, the pigtailed fiber can be customized upon request.

### Application:

Fiber Communication  
Fiber Optic Sensor  
Computed Tomography  
Testing System

### Features:

High Response  
Low Dark Current  
Low Capacitance  
High Reliability



### Absolute Maximum Ratings:

Parameter	Symbol	Value	Unit
Reverse Voltage	Vr	30	V
Forward Current	If	10	mA
Operating Temperature	T	-40~+85	°C
Storage Temperature	T	-40~+85	°C
Solder Temperature	T	260	°C
Lead Solder Time		10	S

Notice: Above specifications should not be exceeded, or the Photodiode will be seriously damaged.

### Optical and Electrical Specification:

Parameter	Symbol	Min.	Tpy.	Max.	Unit	Condition
Wavelength Range	$\lambda$	1100		1650	nm	
Saturated Optical Power	P		2		mW	Vr=5V
Dark Current	Id		0.05	1	nA	Vr=5V
Responsivity	$\lambda=1310\text{nm}$	0.85	0.90		A/W	Vr=0V
	$\lambda=1550\text{nm}$	0.9	0.92		A/W	
Operating Voltage	Vr		5		V	
Breakdown Reverse voltage	Vb			40	V	Ir=10uA
Frequency Bandwidth	Bw		2.5		GHz	
Junction capacitance	Cj		0.3	0.7	Pf	Vr=5V
Active Diameter	Ad		0.1		mm	
Response Time (Raise/Fall)	Tr/Tf		0.25		ns	
Return Loss	RL	45	50		dB	
Fiber Type	SM Fiber					

Notice: Above specifications are tested in room temperature at 25°C.

Specifications may change without notice.

**Drawing:**

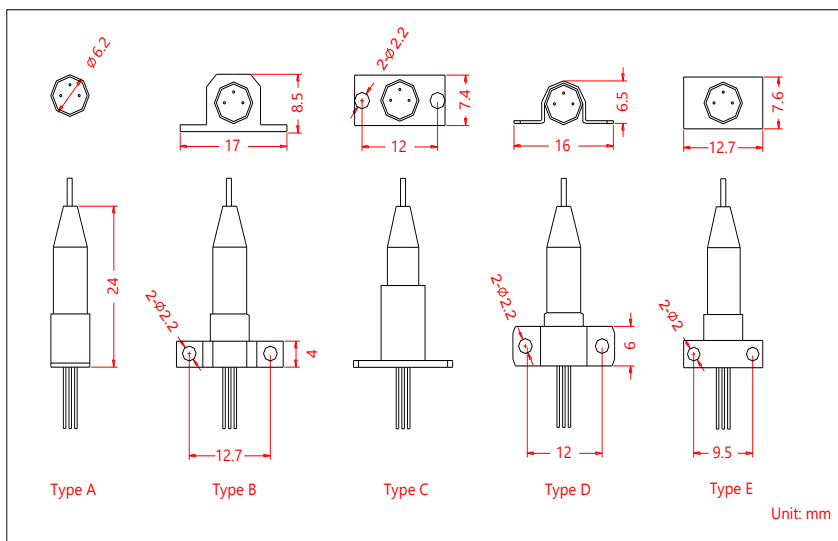

**Pin Information:**

	Type A			Type B			Type C	
	Pin 1	PD +		Pin 1	PD +		Pin 1	PD +
	Pin 2	PD -		Pin 2	PD -		Pin 2	Case
	Pin 3	Case		Pin 3	Case		Pin 3	PD -

**Ordering Information (Part Number):**

SMIPD- <b>WWW</b> - <b>AAA</b> - <b>S</b> - <b>P</b> - <b>J</b> - <b>LL</b> - <b>CC</b>						
<b>WWW</b>	<b>AA</b>	<b>S</b>	<b>P</b>	<b>J</b>	<b>LL</b>	<b>CC</b>
Response Wavelength	Active Diameter	Saddle Type	Pin Assingment	Fiber Jacket	Fiber Length	Connector
1310 - 1310nm	Z05 - Φ0.05mm	A - Type A	A - Type A	B - 250um Bare Fiber	05 - 0.5m	NE - None
1550 - 1550nm	Z07 - Φ0.07mm	B - Type B	B - Type B	L - 900um Loose Tube	10 - 1.0m	FA - FC/APC
SSS - Specify	Z11 - Φ0.11mm	C - Type C	C - Type C		15 - 1.5m	FU - FC/UPC
	Z30 - Φ0.3mm	D - Type D			20 - 2.0m	LA - LC/APC
	SSS - Specify	E - Type E			SS - Specify	LU - LC/UPC
						SA - SC/APC
						SU - SC/UPC
						ST - ST/UPC

**Notification:**

1. The Semiconductor Optoelectronic products are particularly sensitive of ESD (electro-static discharge), it's recommended to use grounded anti-static wrist straps and grounded anti-static mats before handling the products.
2. Always take anti-static measures to storage the products when not in use.

