

## 980nm PM 4-port Optical Circulator

980nm PM 4-port Optical Circulator is a fiber passive component built with TGG crystal, which can change signal light transmission path, one signal can be delivered from Port 1 to Port 2, the second signal light from Port 2 to Port 3, the third signal from port 3 to port 4, the high isolation can block the back reflection light. It's widely used in Fiber Optic Sensor, Fiber Laser and Coherent Detecting field. High Power version is available upon request

### Application:

Fiber Optic Sensor  
Fiber Laser  
Coherent Detecting  
Lab&Research

### Features:

High Extinction Ratio  
High Isolation  
Low Insertion Loss  
High Reliability



### Specification:

Parameter	Symbol	Value	Unit
Center Wavelength	$\lambda$	980	nm
Bandwidth	BW	$\pm 5$	nm
Typ. Insertion Loss (Port 1 to 2, 2 to 3)	IL	1.2	dB
Max. Insertion Loss (Port 1 to 2, 2 to 3)	IL	1.5	dB
Typ. Isolation (Port 2 to 1, 3 to 2)	Iso	25	dB
Min. Isolation (Port 2 to 1, 3 to 2)	Iso	22	dB
Min. Extinction Ratio	ER	20	dB
Min. Cross Talk	Ct	45	dB
Min. Return Loss	RL	45	dB
Max. Optical Power (CW)	P	500	mW
Max. Tensile Load		5	N
Fiber Type		PM Panda fiber	-
Operating Temperature	T	+10~50	°C
Storage Temperature	T	-40~85	°C
Package Dimension			mm

Notice: Above specifications are tested at center wavelength without connector in room temperature @23°C.

For devices with connectors, IL will be 0.3dB higher, ER will be 2dB lower, RL will be 5dB lower.

### Drawing:

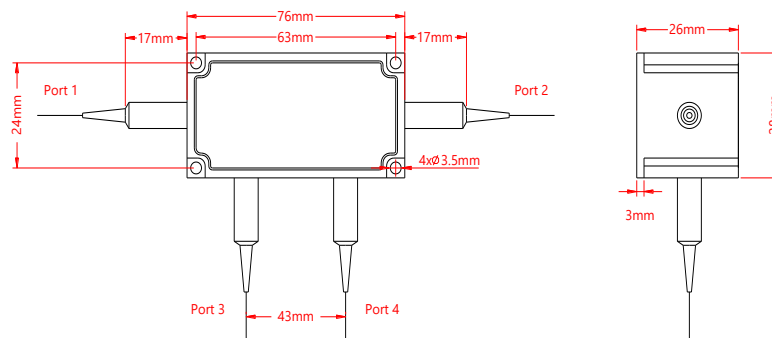

### Ordering Information (Part Number):

PM CIR- <b>WWW</b> - <b>P</b> - <b>A</b> - <b>J</b> - <b>LL</b> - <b>CC</b>					
<b>WWW</b>	<b>P</b>	<b>A</b>	<b>J</b>	<b>LL</b>	<b>CC</b>
Wavelength	Port	Working Axis	Fiber Jacket	Fiber Length	Connector
915 - 915nm	4 - 4 Ports	F - Fast Axis Blocked Slow Axis Working B - Both Axes Working	B - 250um Bare Fiber 9 - 900um Loose Tube	05 - 0.5m	NE - None
930 - 930nm				10 - 1.0m	FA - FC/APC
940 - 940nm				15 - 1.5m	FU - FC/UPC
950 - 950nm				20 - 2.0m	SA - SC/APC
975 - 975nm				SS - Specify	SU - SU/APC
980 - 980nm					LA - LC/APC
SSS - Specify					LU - LC/UPC
					SS - Specify