

705nm PM Pigtailed FP Laser Diode

705nm PM Pigtailed FP (Fabry-Perot) Laser Diode is a semiconductor optoelectronic product which can output stable laser light by the pigtailed polarization maintaining fiber. the Laser Diode with PD built in to monitor the optical signal power. It features low threshold current and high quality laser output, it's widely used in Laser imaging, fiber optic sensor and VIS Application. Higher Power output type is available.

Application:

Data Transmission
Fiber Optic Sensor
Laser Imaging
Testing System

Features:

Low Threshold Current
High Output Power
PD Built In
High Reliability



Absolute Maximum Ratings:

Parameter	Symbol	Value	Unit
LD Forward Current	If	180	mA
LD Reverse Voltage	Vr	2	V
PD Forward Current	If(PD)	2	mA
PD Reverse Voltage	Vr(PD)	20	V
Operating Temperature	T	-10~+70	°C
Storage Temperature	T	-40~+85	°C
Solder Temperature	T	260	°C
Lead Solder Time		10	S

Notice: Above specifications should not be exceeded, or the LD will be seriously damaged.

Optical and Electrical Specification:

Parameter	Symbol	Min.	Tpy.	Max.	Unit	Test Condition
Center Wavelength	λ_o	695	705	715	nm	
Optical Power	Po	5	10	15	mW	CW
Spectral Width @20dB	$\Delta\lambda$		2	3	nm	CW
Threshold Current	Ith		30	60	mA	CW
LD Operating Current	If		75	100	mA	CW, Po=10mW
LD Forward Voltage	Vf		2.5	2.8	V	
PD Dark Current	Id			1000	nA	Vr(PD)=5V
PD Monitor Current	Im	0.15		0.6	mA	
Fiber Type	PM Panda Fiber					

Notice: Above specifications are tested in room temperature at 23°C.

Slow axis is default aligned to the connector key.

Specifications may change without notice.

Drawing:

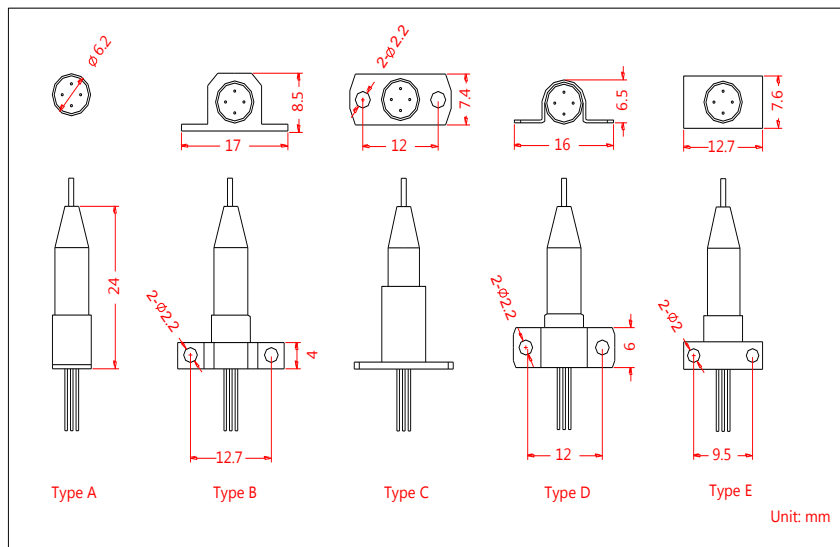

Pin Information:

	Type A		Type B		Type C	
	Pin 1	PD (+)	Pin 1	PD (-)	Pin 1	PD (-)
	Pin 2	LD (+), PD (-)	Pin 2	PD (+)	Pin 2	LD (-)
	Pin 3	Case	Pin 3	LD (+), Case	Pin 3	LD (+), Case
	Pin 4	LD (-)	Pin 4	LD (-)	Pin 4	PD (+)

Ordering Information (Part Number):

PMFPLD- WWW - OO - S - P - J - LL - CC						
WWW	OO	S	P	J	LL	CC
Wavelength	Optical Power	Saddle Type	Pin Assingment	Fiber Jacket	Fiber Length	Connector
705 - 705nm	05 - 5mW 10 - 10mW 15 - 15mW SS - Specify	A - Type A B - Type B C - Type C D - Type D E - Type E	A - Type A B - Type B C - Type C	B - 250um Bare Fiber L - 900um Loose Tube	05 - 0.5m 10 - 1.0m 15 - 1.5m 20 - 2.0m SS - Specify	NE - None FA - FC/APC FU - FC/UPC LA - LC/APC LU - LC/UPC SA - SC/APC SU - SC/UPC SS - Specify

Notification:

1. The Semiconductor Optoelectronic products are particulary sensitive of ESD (electro-static discharge), it's recommended to use grounded anti-static wrist straps and grounded anti-static mats before handling the products.
2. Never plug or unplug the products under a living circuit, setting the current supply to zero before switching on or switching off the laser diode.
3. Always take anti-static measures to storage the products when not in use.

