

461nm PM 3-port Optical Circulator

461nm PM 3-port Optical Circulator is a fiber passive component built with TGG crystal, which can change signal light transmission path, the signal can be delivered from Port 1 to Port 2, the other signal light from Port 2 to Port 3, the high isolation can block the back reflection light. It's widely used in Quantum Communication, Fiber Laser and Coherent Detecting field. If need higher power version please tell us to confirm.

Application:

Quantum Communication
Fiber Laser
Coherent Detecting
Lab&Research

Features:

High Extinction Ratio
High Isolation
Low Insertion Loss
High Reliability



Specification:

Parameter	Symbol	Value	Unit
Center Wavelength	λ	461	nm
Bandwidth	BW	± 5	nm
Typ. Insertion Loss (Port 1 to 2, 2 to 3)	IL	1.2	dB
Max. Insertion Loss (Port 1 to 2, 2 to 3)	IL	1.5	dB
Typ. Isolation (Port 2 to 1, 3 to 2)	Iso	20	dB
Min. Isolation (Port 2 to 1, 3 to 2)	Iso	18	dB
Min. Extinction Ratio	ER	18	dB
Min. Cross Talk	Ct	45	dB
Min. Return Loss	RL	45	dB
Max. Optical Power (CW)	P	300	mW
Max. Tensile Load		5	N
Fiber Type		Nufern PM460-HP fiber	-
Operating Temperature	T	+10~50	°C
Storage Temperature	T	-40~85	°C
Package Dimension			mm

Notice: Above specifications are tested at center wavelength without connector in room temperature @23°C.

For devices with connectors, IL will be 0.3dB higher, ER will be 2dB lower, RL will be 5dB lower.

Drawing:

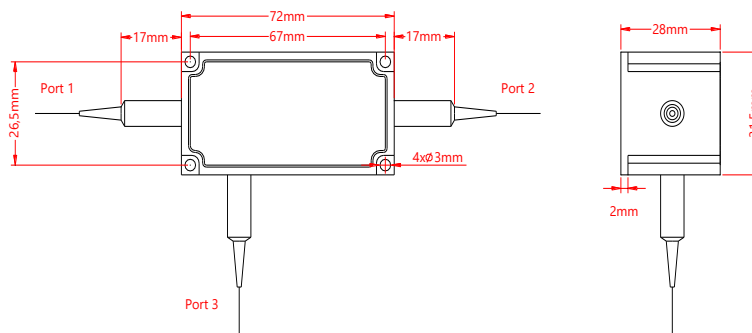

Ordering Information (Part Number):

PM CIR- WWW - P - A - J - LL - CC					
WWW	P	A	J	LL	CC
Wavelength	Port	Working Axis	Fiber Jacket	Fiber Length	Connector
458 - 458nm 461 - 461nm SSS - Specify	3 - 3 Ports	F - Fast Axis Blocked Slow Axis Working B - Both Axes Working	B - 250um Bare Fiber 9 - 900um Loose Tube	05 - 0.5m 10 - 1.0m 15 - 1.5m 20 - 2.0m SS - Specify	NE - None FA - FC/APC FU - FC/UPC SA - SC/APC SU - SU/APC LA - LC/APC LU - LC/UPC SS - Specify