

760nm 3-port Polarization Insensitive Optical Circulator

760nm TGG 3-port Polarization Insensitive Optical Circulator is a fiber passive component built with TGG crystal, which can change signal light transmission path, the signal can be delivered from Port 1 to Port 2, the other signal light from Port 2 to Port 3, the high isolation can block the back reflection light. It's widely used in Fiber Amplifier System, Fiber Optic Sensor and Testing System field. If need higher power version please tell us to confirm.

Application:

Fiber Optic Sensor
Fiber Laser
Coherent Detecting
Fiber Optic Amplifier

Features:

Low PDL
High Isolation
Low Insertion Loss
High Reliability



Specification:

Parameter	Symbol	Value	Unit
Center Wavelength	λ	760	nm
Bandwidth	BW	± 10	nm
Typ. Insertion Loss (Port 1 to 2, 2 to 3)	IL	1.0	dB
Max. Insertion Loss (Port 1 to 2, 2 to 3)	IL	1.5	dB
Typ. Isolation (Port 2 to 1, 3 to 2)	Iso	25	dB
Min. Isolation (Port 2 to 1, 3 to 2)	Iso	22	dB
Max. Polarization Dependent Loss	PDL	0.25	dB
Min. Cross Talk	Ct	45	dB
Min. Return Loss	RL	45	dB
Max. Optical Power (CW)	P	500	mW
Max. Tensile Load		5	N
Fiber Type		HI 780 fiber	-
Operating Temperature	T	+10~50	°C
Storage Temperature	T	-40~85	°C
Package Dimension			mm

Notice: Above specifications are tested at center wavelength without connector in room temperature @23°C.

For devices with connectors, IL will be 0.3dB higher, RL will be 5dB lower.

Drawing:

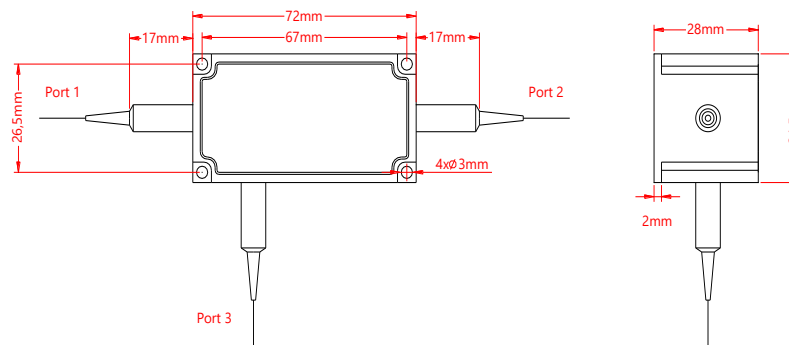

Ordering Information (Part Number):

PICIR- WWW - P - J - LL - CC				
WWW	P	J	LL	CC
Wavelength	Port	Fiber Jacket	Fiber Length	Connector
760 - 760nm	3 - 3 Ports	B - 250um Bare Fiber	05 - 0.5m	NE - None
780 - 780nm		9 - 900um Loose Tube	10 - 1.0m	FA - FC/APC
785 - 785nm			15 - 1.5m	FU - FC/UPC
790 - 790nm			20 - 2.0m	SA - SC/APC
793 - 793nm			SS - Specify	SU - SU/APC
SSS - Specify				LA - LC/APC
				LU - LC/UPC
				SS - Specify