

## High Power 820nm PM 3-port Optical Circulator

High Power 820nm Polarization Maintaining (PM) 3-port Optical Circulator is a fiber passive component built with TGG crystal, which can change signal light transmission path, the signal can be delivered from Port 1 to Port 2, the other signal light from Port 2 to Port 3, the high isolation can block the back reflection light. It's widely used in Laser System, Fiber Optic Sensor and Coherent Detecting field. If need pulse type please contact us to confirm.

### Application:

Fiber Optic Amplifier  
Fiber Optic Sensor  
Laser System  
Coherent Detecting

### Features:

High Power  
High Extinction Ratio  
High Isolation  
High Reliability



### Specification:

Parameter	Symbol	Value	Unit
Center Wavelength	$\lambda$	820	nm
Bandwidth	BW	$\pm 5$	nm
Typ. Insertion Loss (Port 1 to 2, 2 to 3)	IL	1.3	dB
Max. Insertion Loss (Port 1 to 2, 2 to 3)	IL	1.5	dB
Typ. Isolation (Port 2 to 1, 3 to 2)	Iso	28	dB
Min. Isolation (Port 2 to 1, 3 to 2)	Iso	22	dB
Min. Extinction Ratio	ER	20	dB
Min. Cross Talk	Ct	45	dB
Min. Return Loss	RL	45	dB
Max. Optical Power (CW)	P	1, 3, 5 or specify	W
Max. Peak Power	P	5, 10 or specify	kW
Max. Tensile Load		5	N
Fiber Type		PM Panda fiber	-
Operating Temperature	T	+5~65	°C
Storage Temperature	T	-40~85	°C
Package Dimension			mm

Notice: Above specifications are tested at center wavelength without connector in room temperature @23°C.

For devices with connectors, IL will be 0.3dB higher, RL will be 5dB lower, ER will be 2dB lower.

Slow axis is default aligned to the connector key. Connectors only 1W CW optical power guarantee.

### Drawing:

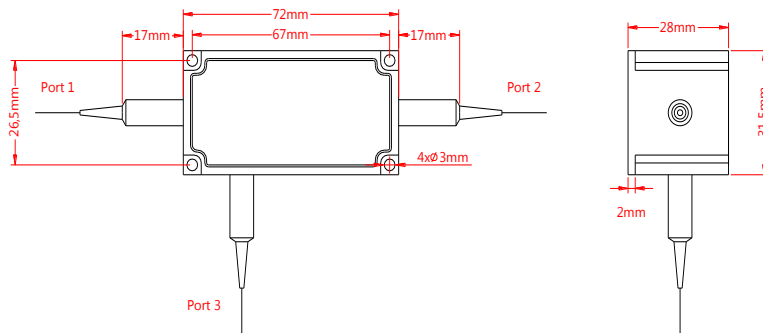

### Ordering Information (Part Number):

HPMCIR- <b>WWW</b> - <b>P</b> - <b>A</b> - <b>HH</b> - <b>J</b> - <b>LL</b> - <b>CC</b>						
<b>WWW</b>	<b>P</b>	<b>A</b>	<b>HH</b>	<b>J</b>	<b>LL</b>	<b>CC</b>
Wavelength	Port	Working Axis	Handling Power	Fiber Jacket	Fiber Length	Connector
800 - 800nm	3 - 3 Ports	F - Fast Axis Blocked Slow Axis Working B - Both Axes Working	01 - 1W	B - 250um Bare Fiber 9 - 900um Loose Tube	05 - 0.5m	NE - None
808 - 808nm			03 - 3W		10 - 1.0m	FA - FC/APC
810 - 810nm			05 - 5W		15 - 1.5m	FU - FC/UPC
820 - 820nm			SS - Specify		20 - 2.0m	SA - SC/APC
830 - 830nm					SS - Specify	SU - SU/APC
850 - 850nm						LA - LC/APC
SSS - Specify						LU - LC/UPC
				SS - Specify		