

1480nm 2x2 Polarization Beam Combiner/Splitter

1480nm 2x2 Polarization Beam Combiner/Splitter is a fiber passive component which can combine the two orthogonal polarization light into one output fiber or split the orthogonal polarization light to two output fiber, it's widely used in Fiber Amplifier System and Fiber Optic Diffraction field, the high power type is available upon request.

Application:

Fiber Optic Amplifier
Fiber Optic Sensor
Laser System
Fiber Optic Diffraction

Features:

High Extinction Ratio
Low Insertion Loss
Optical Path Reversibility
High Reliability

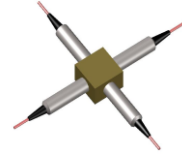

Specification:

Parameter	Symbol	Value	Unit
Center Wavelength	λ	1480	nm
Bandwidth	BW	± 20	nm
Insertion Loss	Port 3 to 1&2 @ slow axis	Max. 0.8, Typ. 0.6	dB
	Port 4 to 1&2 @ fast axis		
Min. Extinction Ratio (For PBS)	ER	20	dB
Min. Directivity		50	dB
Min. Return Loss	RL	50	dB
Max. Optical Power (CW)	P	500	mW
Max. Tensile Load		5	N
Fiber Type	For Port 1 and Port 2	PM Panda fiber	-
	For Port 3 and Port 4	PM Panda fiber or SMF-28e fiber	-
Operating Temperature	T	-5~70	°C
Storage Temperature	T	-40~85	°C
Package Dimension			mm

Notice: Above specifications are tested at center wavelength without connector in room temperature @23°C.

For devices with connectors, IL will be 0.3dB higher, RL will be 5dB lower, ER will be 2dB lower, slow axis is default aligned to the connector key.

Drawing:

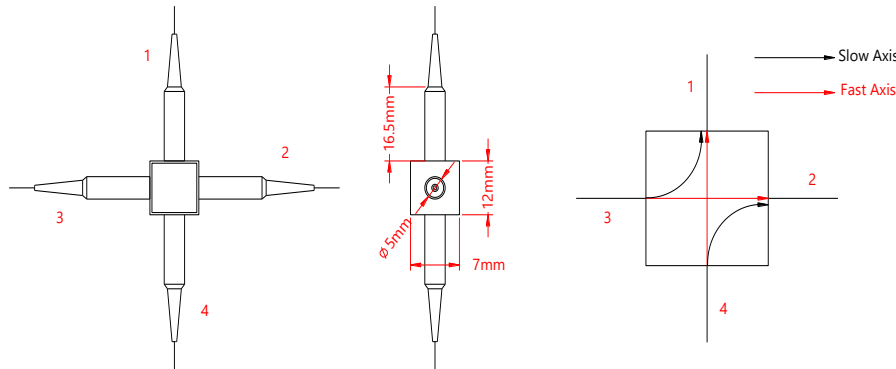

Ordering Information (Part Number):

DPBCS- WWW - FF - J - LL - CC				
WWW	FF	J	LL	CC
Wavelength	Fiber Type on Port 3 and Port 4	Fiber Jacket	Fiber Length	Connector
1310 - 1310nm	S2 - SMF-28e Fiber	B - 250um Bare Fiber	05 - 0.5m	NE - None
1450 - 1450nm	PM - PM Panda Fiber,	9 - 900um Loose Tube	10 - 1.0m	FA - FC/APC
1480 - 1480nm	Slow Axis Aligned to Port 1		15 - 1.5m	FU - FC/UPC
1550 - 1550nm	P4 - PM Panda Fiber,		20 - 2.0m	SA - SC/APC
1580 - 1580nm	Slow Axis 45° Aligned to Port 1		SS - Specify	SU - SU/APC
	SS - Specify			LA - LC/APC
				LU - LC/UPC
				SS - Specify