

High Power 650nm PM 3-port Optical Circulator

High Power 650nm Polarization Maintaining (PM) 3-port Optical Circulator is a fiber passive component built with TGG crystal, which can change signal light transmission path, the signal can be delivered from Port 1 to Port 2, the other signal light from Port 2 to Port 3, the high isolation can block the back reflection light. It's widely used in Laser System, Fiber Optic Sensor and Coherent Detecting field.

Application:

Fiber Optic Amplifier
Fiber Optic Sensor
Laser System
Coherent Detecting

Features:

High Power
High Extinction Ratio
High Isolation
High Reliability



Specification:

Parameter	Symbol	Value	Unit
Center Wavelength	λ	650	nm
Bandwidth	BW	± 10	nm
Typ. Insertion Loss (Port 1 to 2, 2 to 3)	IL	1.5	dB
Max. Insertion Loss (Port 1 to 2, 2 to 3)	IL	2.0	dB
Typ. Isolation (Port 2 to 1, 3 to 2)	Iso	23	dB
Min. Isolation (Port 2 to 1, 3 to 2)	Iso	20	dB
Min. Extinction Ratio	ER	20	dB
Min. Cross Talk	Ct	40	dB
Min. Return Loss	RL	40	dB
Max. Optical Power (CW)	P	1, 2 or specify	W
Max. Peak Power	P	5, 10 or specify	kW
Max. Tensile Load		5	N
Fiber Type		PM Panda fiber	-
Operating Temperature	T	+5~65	°C
Storage Temperature	T	-40~85	°C
Package Dimension			mm

Notice: Above specifications are tested at center wavelength without connector in room temperature @23°C.

For devices with connectors, IL will be 0.3dB higher, RL will be 5dB lower, ER will be 2dB lower.

Slow axis is default aligned to the connector key. Connectors only 1W CW optical power guarantee.

Drawing:

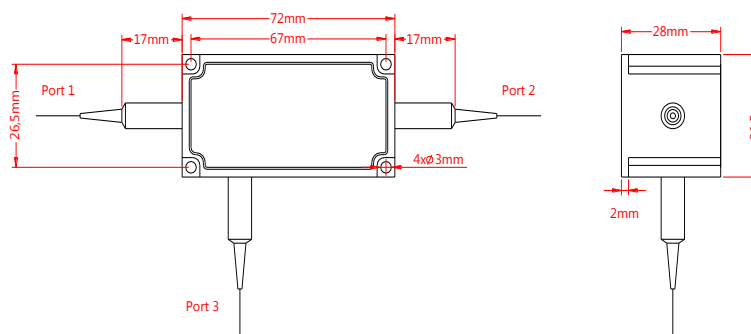

Ordering Information (Part Number):

HPMCIR-**WWW**-**P**-**A**-**HH**-**J**-**LL**-**CC**

WWW	P	A	HH	J	LL	CC
Wavelength	Port	Working Axis	Handling Power	Fiber Jacket	Fiber Length	Connector
488 - 488nm	3 - 3 Ports	F - Fast Axis Blocked Slow Axis Working	01 - 1W	B - 250um Bare Fiber 9 - 900um Loose Tube	05 - 0.5m	NE - None
532 - 532nm			02 - 2W		10 - 1.0m	FA - FC/APC
633 - 633nm		B - Both Axes Working	SS - Specify		15 - 1.5m	FU - FC/UPC
635 - 635nm			20 - 2.0m		SA - SC/APC	
650 - 650nm			SS - Specify		SU - SU/APC	
680 - 680nm			LA - LC/APC			
SSS - Specify			LU - LC/UPC			
	SS - Specify					