

780nm 1x1 PM Mechanical Optical Switch

780nm 1x1 PM Mechanical Optical Switch is an optoelectronic passive product which can switch or operate the light signal in the optical transmission line or integrated optical path. It's widely used in fiber communication, fiber optic sensor and optical testing systems, high power type is available upon request.

Application:

Fiber Communication
Fiber Optic Sensor
Optical Testing System
Lab & Research

Features:

Low Insertion Loss
High Extinction Ratio
RoHs Compliant
High Reliability



Specification:

Parameter	Symbol	Value	Unit
Center Wavelength	λ	780	nm
Bandwidth	BW	± 30	nm
Typ. Insertion Loss	IL	1.1	dB
Max. Insertion Loss	IL	1.5	dB
Min. Extinction Ratio	ER	16	dB
Max. Wavelength Dependent Loss	WDL	0.25	dB
Max. Temperature Dependent Loss	TDL	0.25	dB
Min. Return Loss	RL	40	dB
Min. Cross Talk		40	dB
Max. Repeatability		± 0.02	dB
Power Supply		3.0 or 5.0	V
Min. Life Time		10^6	Cycle
Max. Switching Time		8	ms
Max. Optical Power (CW)	P	500	mW
Max. Tensile Load		5	N
Fiber Type		PM 850 Panda Fiber	-
Operating Temperature	T	-20~70	$^{\circ}\text{C}$
Storage Temperature	T	-40~85	$^{\circ}\text{C}$
Package Dimension		L27xW12xH8.2	mm

Notice: Above specifications are tested at center wavelength without connector in room temperature @23 $^{\circ}\text{C}$.

For devices with connectors, IL will be 0.3dB higher, ER will be 2dB lower, RL will be 5dB lower. Slow axis is default aligned to the connector key.

Drawing:

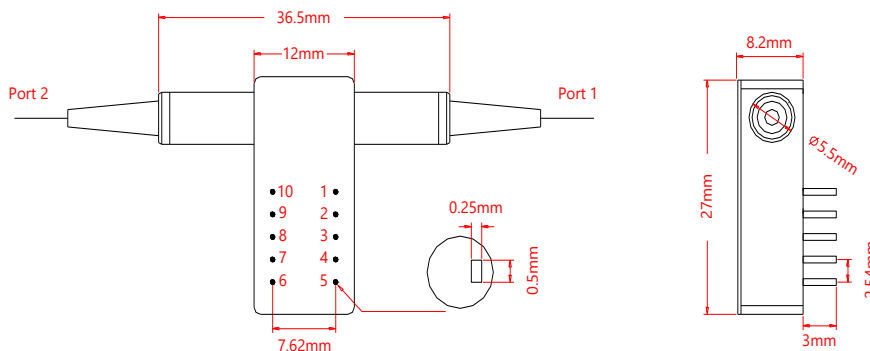

Pin Information:

Type for 1x1	Optical Path	Electric Drive				Status Sensor			
		Pin 1	Pin 5	Pin 6	Pin 10	Pin 2-3	Pin 3-4	Pin 7-8	Pin 8-9
Latching	Port 1 - Port 2	V+	GND	-	-	Open	Close	Close	Open
	Light Close	-	-	GND	V+	Close	Open	Open	Close
Non-latching	Port 1 - Port 2	V+	-	-	GND	Open	Close	Close	Open
	Light Close	-	-	-	-	Close	Open	Open	Close

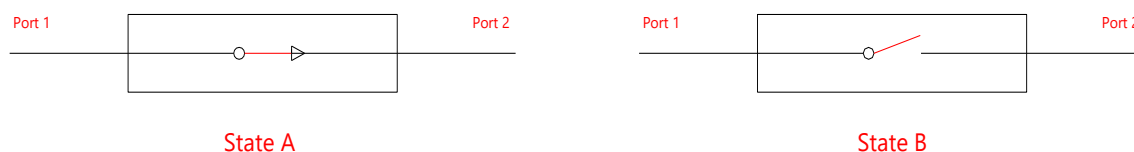
Optical Path:**Electric:**

Type	Voltage	Current	Resistance
5V Latching	4.5~5.5V	36~44mA	125Ω
5V Non-latching	4.5~5.5V	26~32mA	175Ω
3V Latching	2.7~3.3V	54~66mA	50Ω
3V Non-latching	2.7~3.3V	39~47mA	70Ω

Ordering Information (Part Number):PMSW-**WWW**-**CC**-**M**-**D**-**J**-**LL**-**CC**

WWW	CC	M	D	J	LL	CC
Wavelength	Configuration	Mode	Driving Voltage	Fiber Jacket	Fiber Length	Connector
780 - 780nm	11 - 1x1	L - Latching N - Non-latching	3 - 3V 5 - 5V	B - 250um Bare Fiber 9 - 900um Loose Tube	05 - 0.5m 10 - 1.0m 15 - 1.5m 20 - 2.0m SS - Specify	NE - None FA - FC/APC FU - FC/UPC SA - SC/APC SU - SU/APC LA - LC/APC LU - LC/UPC SS - Specify