

High Power 785nm 3-port Polarization Insensitive Optical Circulator

High Power 785nm 3-port Polarization Insensitive Optical Circulator is a fiber passive component built with TGG crystal, which can change signal light transmission path, the signal can be delivered from Port 1 to Port 2, the other signal light from Port 2 to Port 3, the high isolation can block the back reflection light. It's widely used in Fiber Amplifier System, Fiber Optic Sensor and Testing System field. If need pulse type please tell us to confirm.

Application:

Fiber Optic Sensor
Fiber Optic Amplifier
Coherent Detecting
Testing System

Features

High Power
High Isolation
Low Insertion Loss
High Reliability



Specification:

Parameter	Symbol	Value	Unit
Center Wavelength	λ	785	nm
Bandwidth	BW	± 5	nm
Typ. Insertion Loss (Port 1 to 2, 2 to 3)	IL	1.2	dB
Max. Insertion Loss (Port 1 to 2, 2 to 3)	IL	1.5	dB
Typ. Isolation (Port 2 to 1, 3 to 2)	Iso	25	dB
Min. Isolation (Port 2 to 1, 3 to 2)	Iso	22	dB
Max. Polarization Dependent Loss	PDL	0.15	dB
Min. Cross Talk	Ct	50	dB
Min. Return Loss	RL	45	dB
Max. Optical Power (CW)	P	1, 3, 5 or specify	W
Max. Peak Power	P	5, 10 or specify	kW
Max. Tensile Load		5	N
Fiber Type		HI 780 fiber	-
Operating Temperature	T	+5~65	°C
Storage Temperature	T	-40~85	°C
Package Dimension			mm

Notice: Above specifications are tested at center wavelength without connector in room temperature @23°C.

For devices with connectors, IL will be 0.3dB higher, RL will be 5dB lower. connectors only 1W CW optical power guarantee.

Drawing:

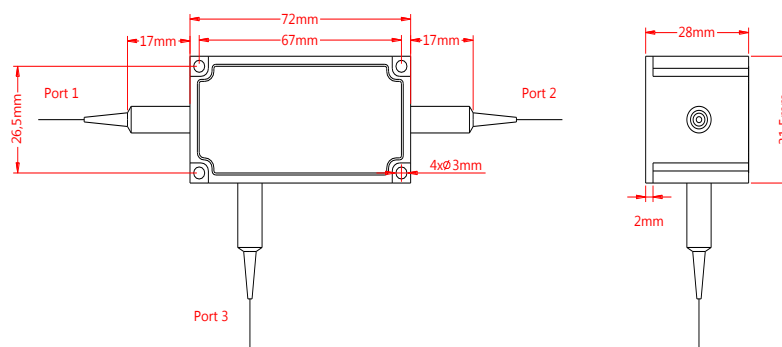

Ordering Information (Part Number):

HPICIR-**WWW**-**P**-**HH**-**J**-**LL**-**CC**

WWW	P	HH	J	LL	CC
Wavelength	Port	Handling Power	Fiber Jacket	Fiber Length	Connector
780 - 780nm	3 - 3 Ports	01 - 1W	B - 250um Bare Fiber	05 - 0.5m	NE - None
785 - 785nm		03 - 3W	9 - 900um Loose Tube	10 - 1.0m	FA - FC/APC
790 - 790nm		05 - 5W		15 - 1.5m	FU - FC/UPC
793 - 793nm		SS - Specify		20 - 2.0m	SA - SC/APC
SSS - Specify				SS - Specify	SU - SU/APC
					LA - LC/APC
					LU - LC/UPC
					SS - Specify